

# Water Heater Unit



**Thermo Top C Additional Heater**

  
00 0002

## Upgrade Instructions

### Kia Carnival

Diesel  
from Model Year 2006  
For left-hand drive vehicles only



#### **WARNING!**

**Hazard warning:**

**Incorrect installation or repair of Webasto heating systems may cause a fire or result in the emission of carbon monoxide, which can be fatal. Serious or fatal injuries can be caused as a result.**

**Specialist company training, technical documentation, specialized tools and equipment are required to install and repair Webasto heating and cooling systems.**

**NEVER attempt to install or repair Webasto heating or cooling systems if you have not successfully completed the company training and thereby acquired the required technical skills, or if you do not have access to the required technical documentation, tools and equipment needed to carry out correct installation and repairs.**

**ALWAYS follow all Webasto installation and repair instructions and observe all warnings.**

**Webasto does not accept any liability for defects and damage that are attributable to installation by untrained staff.**

## Table of Contents

Validity	2
Upgrade Kit	3
Foreword	3
General Instructions	3
Preliminary Work	5
Heater unit installation location	5
Coolant connection	6
Electrical Connections	9
Connection of heater unit, water pump and temp. switch	12
Connection of heater unit, water pump and temp. switch	12
Remote option (Telestart)	13
Final Work	14
Operating Instructions for End Customer	15

## Validity

Manufacturer	Model	Type	EG-BE No./ABE
Kia	Carnival	MB	e4 * 2001 / 116 * 0112 *

Engine type	Engine model	Output in kW	Displacement in cm <sup>3</sup>
J3	Diesel	136	2902

Vehicle and engine types, equipment variants and national specifications not listed in these installation instructions have not been tested. However, installation according to these installation instructions may be possible.

The installation location of a digital timer and summer/winter switch should be confirmed with the end customer before installation.

## Upgrade Kit

Quantity	Description	Order No.:
1	Upgrade kit for Kia Carnival Diesel	9016122A



### Foreword

The upgrade instructions apply to the Kia Carnival vehicles with a Diesel engine

- For the validity, see page 2 - from model year 2006 and later, assuming technical modifications to the vehicle do not affect installation, any liability claims excluded. Depending on the vehicle version and equipment, modifications may be necessary during installation with respect to these installation instructions.

However, the stipulations in the "installation instructions" and "operating and maintenance instructions" for the *Thermo Top C/P/E* must always be observed.

The corresponding rules of technology and any information from the vehicle manufacturer should be observed during the installation work.

### General Instructions

Installation should be carried out according to the general, standard rules of technology. Unless specified otherwise, fasten hoses, lines and wiring harnesses to original vehicle lines and wiring harnesses using cable ties.

Sharp edges should be fitted with edge protectors (split-open plastic hose).

Spray unfinished body areas, e.g. drilled holes, with anti-corrosion wax (Tectyl 100K, Order No. 111329).

### Special Tools

- Hose clamping pliers

**Explanatory Notes on Document**

To provide you with a quick overview of the individual working steps, you will find an identification mark on the outside top right corner of the page in question.

**Mechanical system**



**Electrical system**



**Coolant connection**



**Fuel connection**



**Exhaust system**

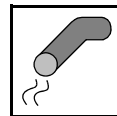

**Combustion air**



Special features are highlighted using the following symbols:



Specific risk of injury or fatal accidents.



Specific risk of damage to components.



Specific risk of fire or explosion.



Reference to general installation instructions of Webasto components or to the manufacturer's vehicle-specific documents.



Reference to a special technical feature.

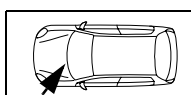
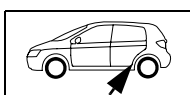

The arrow in the vehicle icon indicates the position on the vehicle and the viewing angle.

## Preliminary Work

### WARNING!

- Disconnect the battery "earth" or "ground" connection.
- Depressurize the cooling system.
- Remove the entire air filter
- Disconnect the engine control unit
- Disconnect the fuse and relay box located in the center of the firewall
- Remove the A/C control panel (only with automatic air-conditioning)
- Remove the trim of the fan motor in the footwell on the front passenger side
- Please remove page 15 of the "Operating instructions for the end customer" and add this to the vehicle operating instructions.

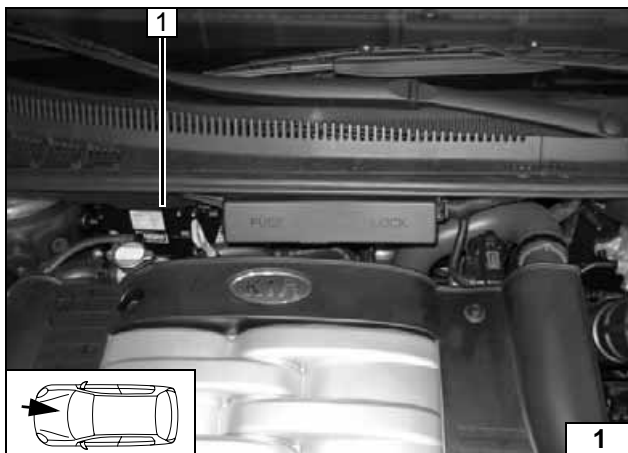

### Heater unit installation location

- 1 Heater unit

Installation location



**Coolant connection**

**WARNING!**

Tighten all hose clamps to 2.0 + 0.5 Nm.

Any coolant running off should be collected using an appropriate container!

Install hoses so that they are kink-free. Unless specified otherwise, always fasten using cable ties. Position hose clamps and spring band clamps so that no other hose can be damaged.

The connection should be "inline" based on the following diagram:

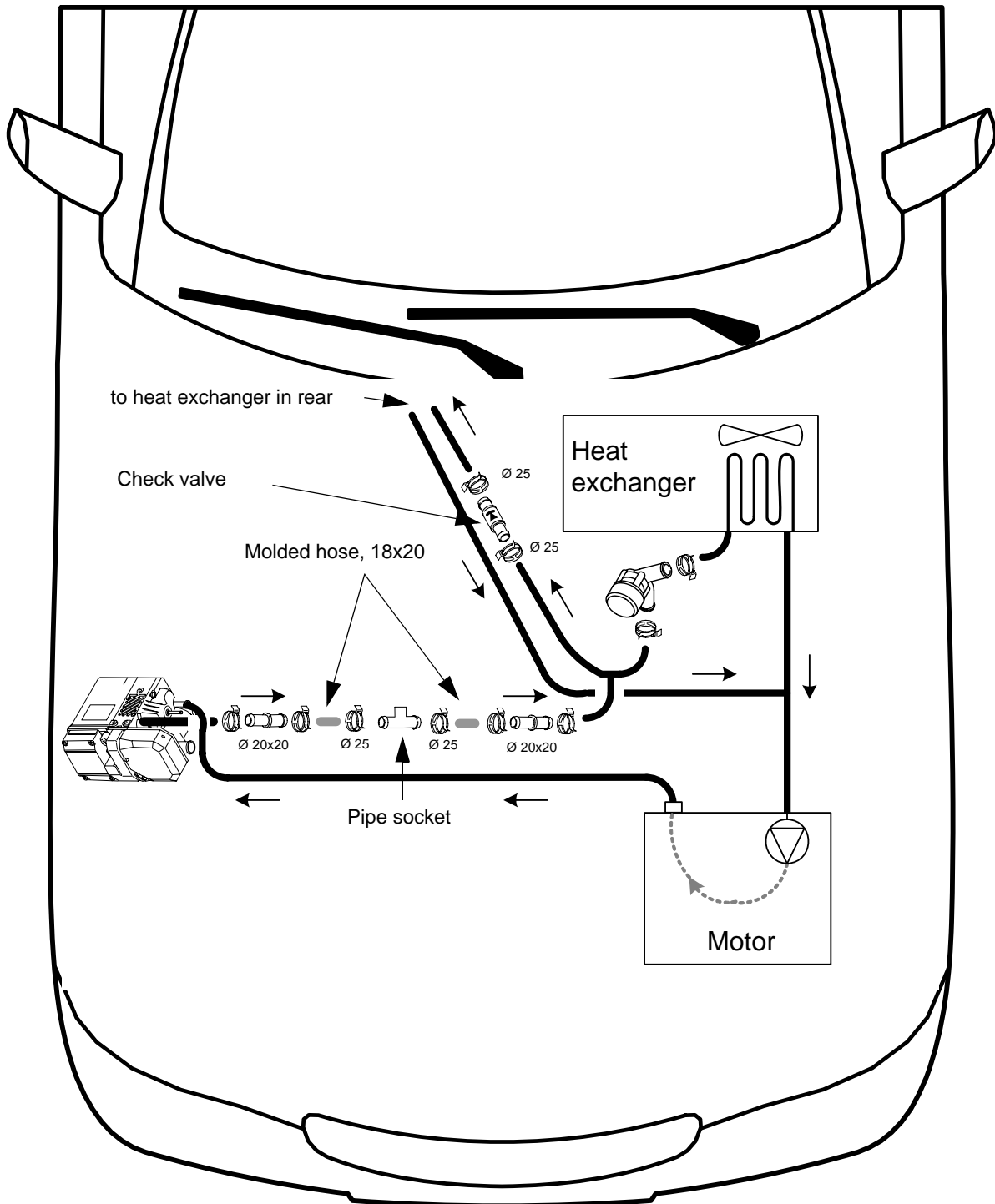

Coolant routing diagram

All clamps without a specific designation = 27 mm dia. hose clamps!



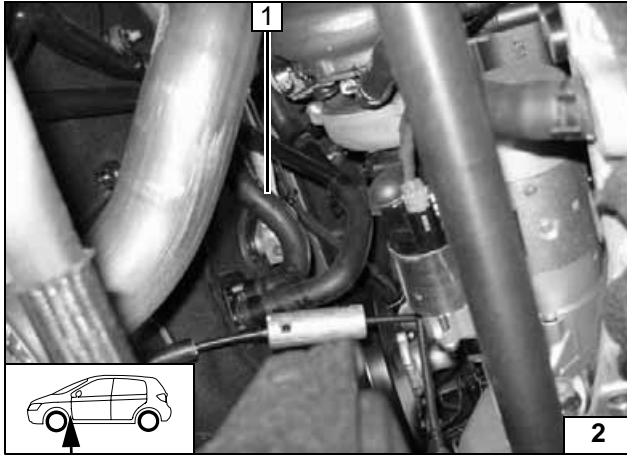

1 Remove hose from heat exchanger inlet (clips will be reused)

Removing hose on heat exchanger inlet

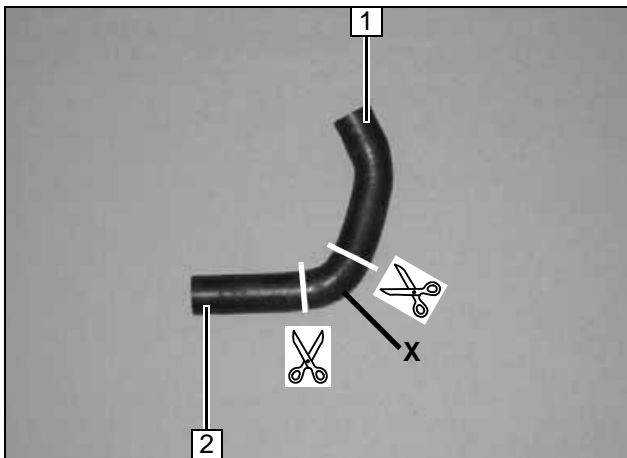

Discard section X.

1 Hose from heater unit outlet  
2 Hose to heat exchanger inlet



Cutting hose to heat exchanger inlet

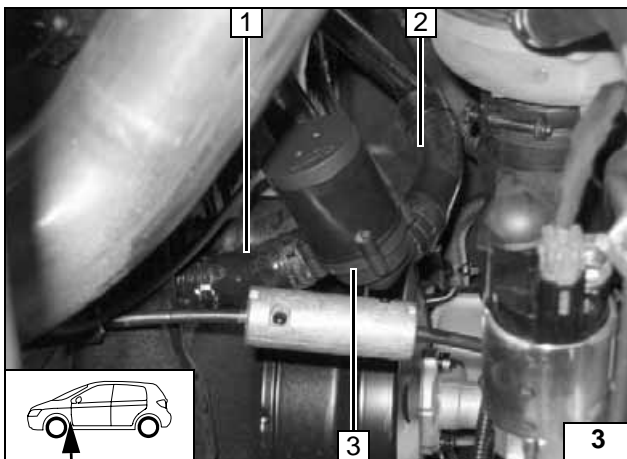

When installing water pump, watch direction of flow!

1 Hose on heat exchanger inlet  
2 Hose from heater unit outlet  
3 Water pump



Installing water pump

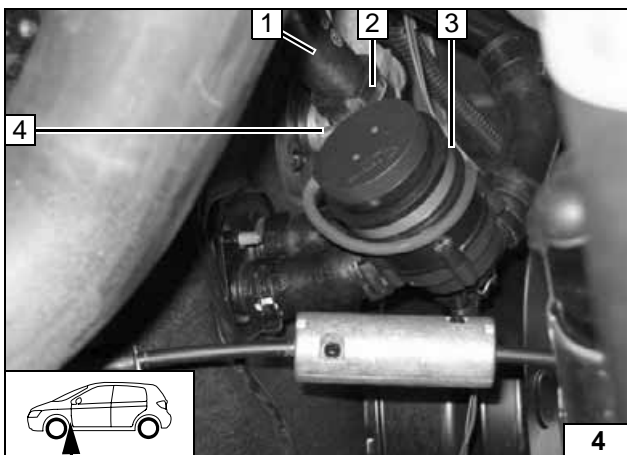

1 Original vehicle hose  
2 Rubber-coated pipe clamp, 25 mm dia.  
3 Rubber-coated pipe clamp, 48 mm dia.  
4 M6x25 bolt, M6 flanged nut

Fastening water pump

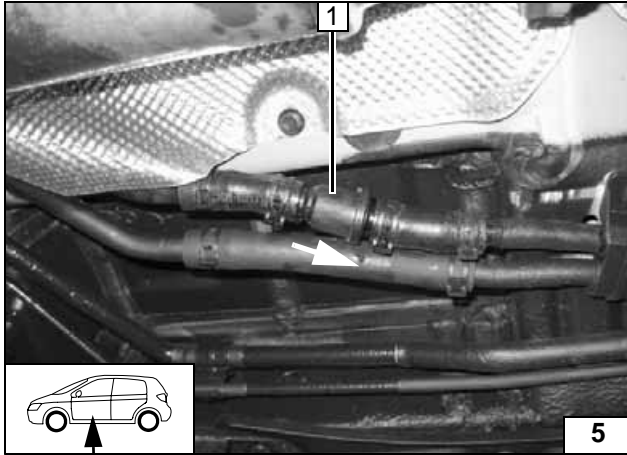

When installing check valve 1, watch direction of flow!



**Installing check valve**

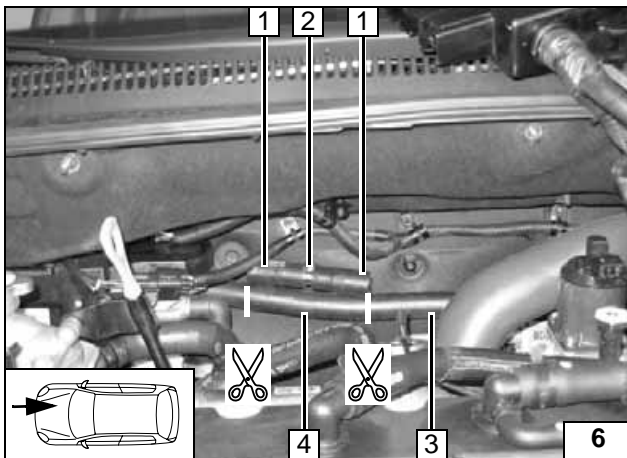

Loosely push 18X20 molded hoses 1 [2x] onto auf pipe socket 2 and position on hose 3. Copy cutting point, cut hose 3 and discard hose section 4.



**Installing thermostat**

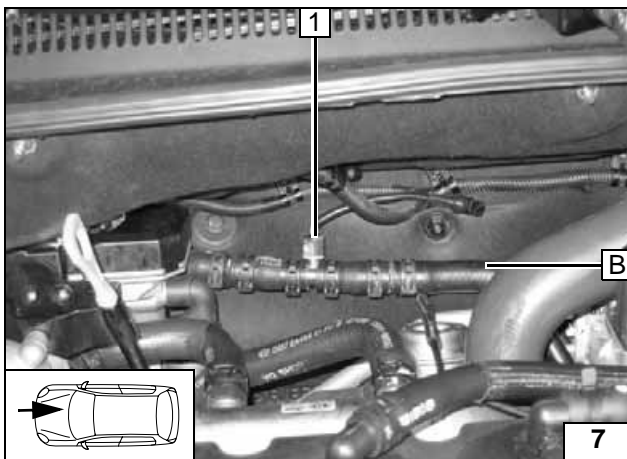

1 Temperature switch in pipe socket

**Installing temperature switch**





**Electrical Connections**

**Positive connection**

- 1 Original vehicle nut, M6
- 2 Wire to positive power supply

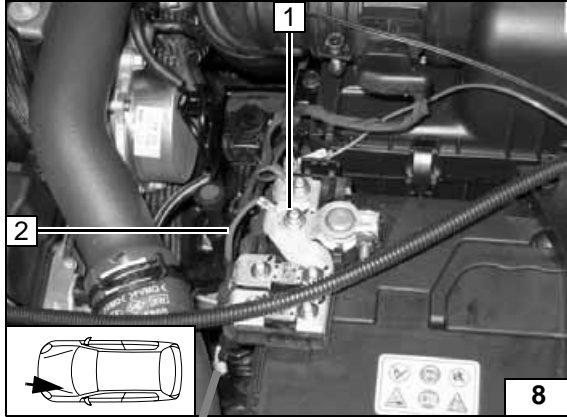

**Digital timer and summer/winter switch option**

- 1 Digital timer
- 2 Summer/winter switch, drilled hole 12 mm dia.

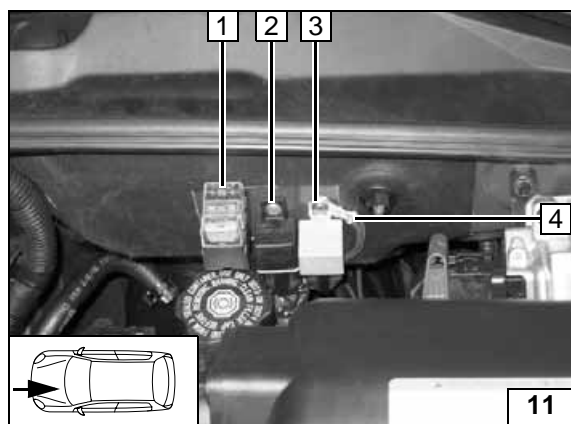
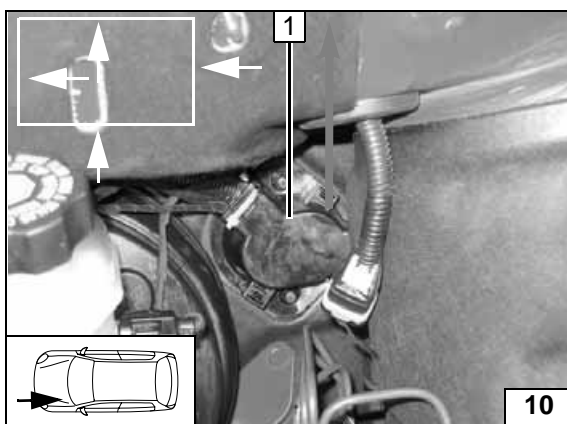
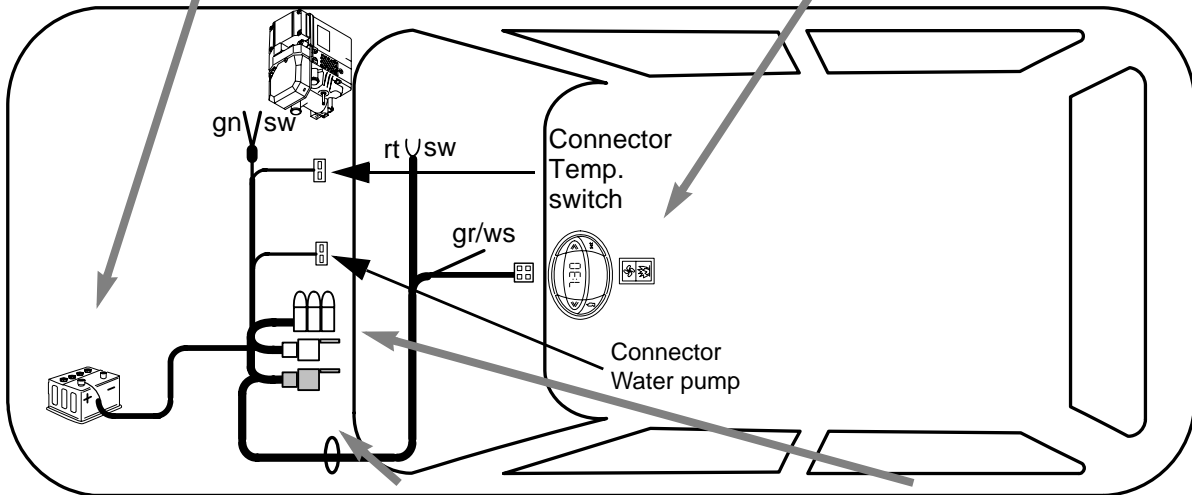

**Wiring harness pass through**

- 1 Wiring harness pass through

**Cut out insulating mat as shown.**

**Fuse holder, relay K3**

- 1 2.0 mm hole, retaining plate, countersunk head self-tapping screw, fuse holder
- 2 5.5 mm dia. hole, self-tapping screw, K3 relay
- 3 5.5 mm dia. hole, self-tapping screw, relay K3.1
- 4 Ground wires



**Wiring harness installation diagram**



Automatic air-conditioning fan controller

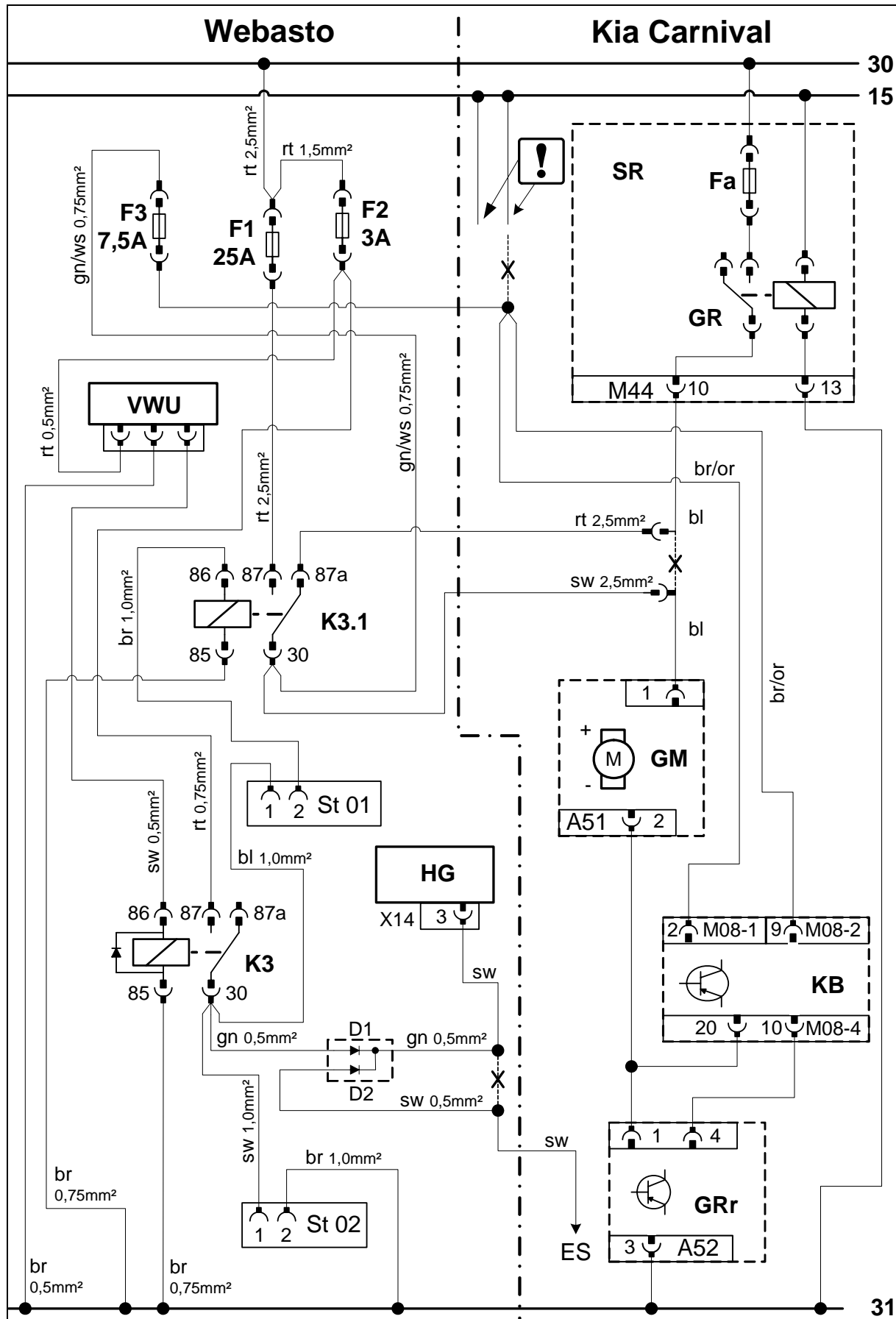

Automatic air-conditioning circuit diagram



Webasto components		Components of Kia Carnival		Colors and symbols	
F1	Fuse, 25 A	GM	Fan motor	rt	red
F2	Fuse, 3 A	GR	Fan relay	or	orange
F3	Fuse, 7.5 A	GRr	Fan controller	sw	black
VWU	Digital timer	KB	Air-conditioning control element	br	brown
HG	Heater unit	M08-1	Connector KB	gn	green
K3	Fan relay	M08-2	Connector KB	bl	blue
K3.1	Additional relay	M08-4	Connector KB	ws	white
St 01	Temp. switch connector	A51	Connector GM	X	Cutting point
ST 02	Circulating pump connector	A52	Connector GRr	<b>!</b>	Insulate wire ends and tie back
D1 and D2	Diodes, 1 A, mounted in wiring harness	M44	Connector GR		
		ES	Switch-on signal		
				Wiring colors may vary.	

## Legend

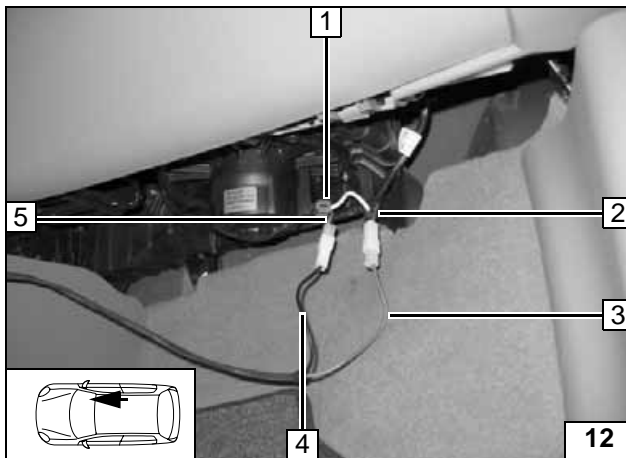

Connection to 2-pin connector A51 1 from fan motor.  
Make connections as shown in the wiring diagram with the tab receptacles provided.

- 2 Blue (bl) wire from fan relay GR
- 3 Red (rt) wire from K3.1/87a
- 4 Black (sw) wire from K3.1/30
- 5 Blue (bl) wire to connector A51



## Connecting fan motor

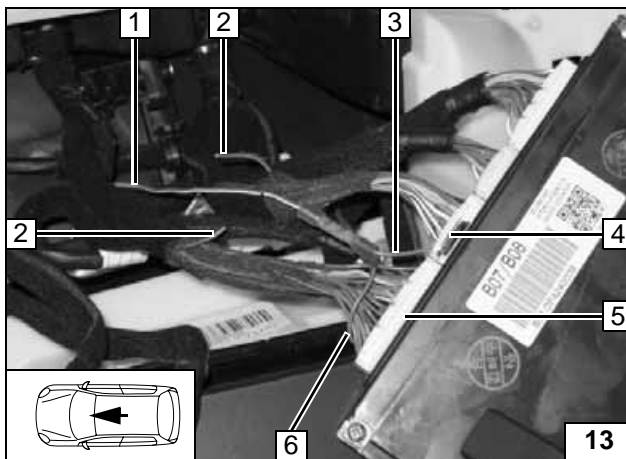

Connection on connector 4 and 5 from A/C control panel!  
Make connections as shown in wiring diagram with connectors provided.

- 1 Gray/white (gr/ws) wire from fuse F3
- 2 Insulate brown/orange (br/or) wire [2x] and tie back
- 3 Brown/orange (br/o) wire to connector M08-2, Pin 9
- 4 Connector M08-2
- 5 Connector M08-1
- 6 Brown/orange (br/o) wire to connector M08-1, Pin 2



## Connecting air-conditioning control element

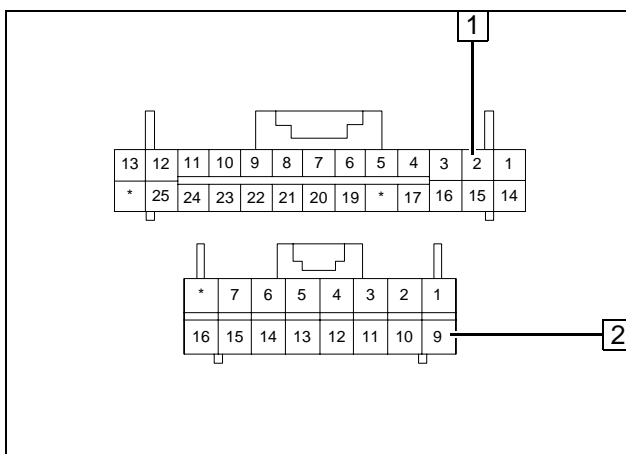

Picture shows connector on contact side!

- 1 Connector M08-1, Pin 2
- 2 Connector M08-2, Pin 9



## View of connector of automatic air-conditioning

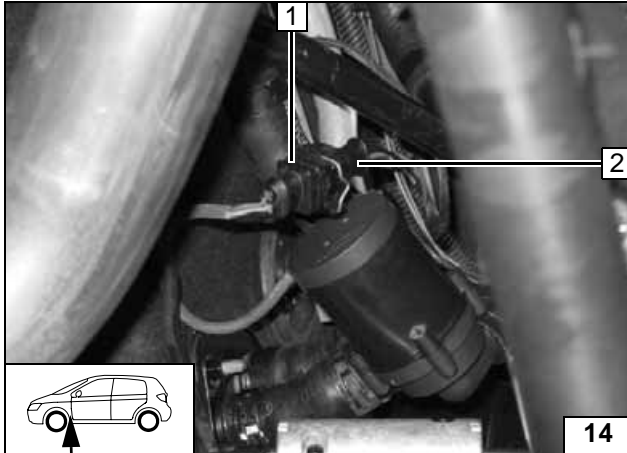

## Connection of heater unit, water pump and temp. switch

Produce connection as shown in wiring diagram.

- 1 Wire with water pump connector
- 2 Line with connector St 02



**Conne-  
tion to wa-  
ter pump**

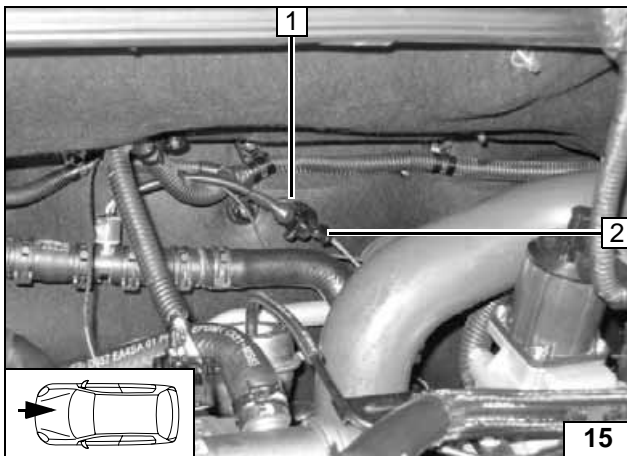

Produce connection as shown in wiring diagram.

- 1 Wire with temperature switch connector
- 2 Line with connector ST 01



**Conne-  
tion to tem-  
perature  
switch**

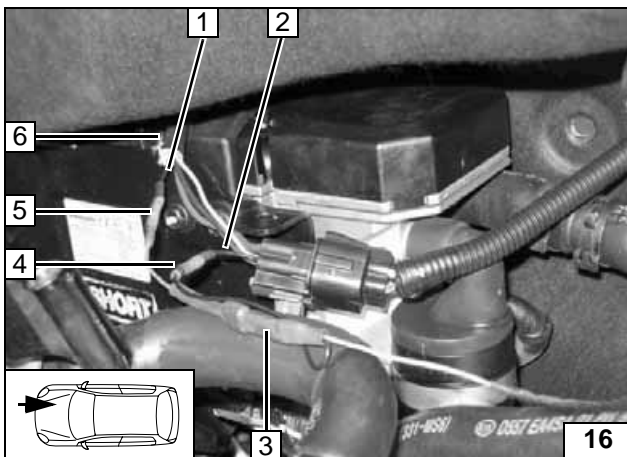

Connection to 6-pin connector E10 3 from fan controller.

Produce connections as shown in wiring diagram. Shorten insulation 6.

- 1 Black (sw) wire to heater unit connector, Pin 3
- 2 Black (sw) wire from 6-pin connector E10, Pin 3
- 3 Diode group
- 4 Black (sw) wire with connector from diode group
- 5 Green (gn) wire with connector from diode group



**Conne-  
tion to  
heater unit**

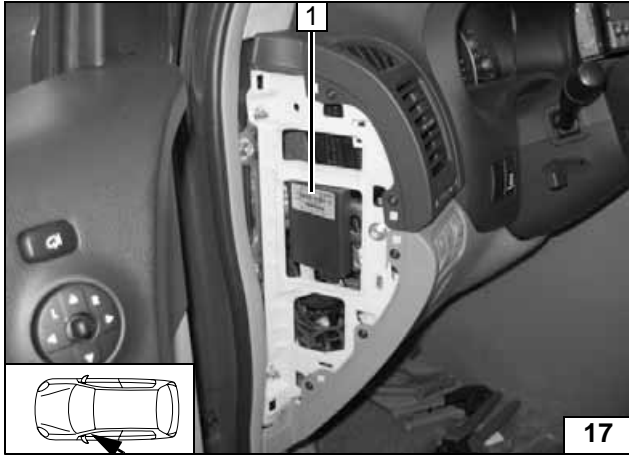

**Remote option (Telestart)**

1 Receiver, installation strap on body



**Installing receiver**

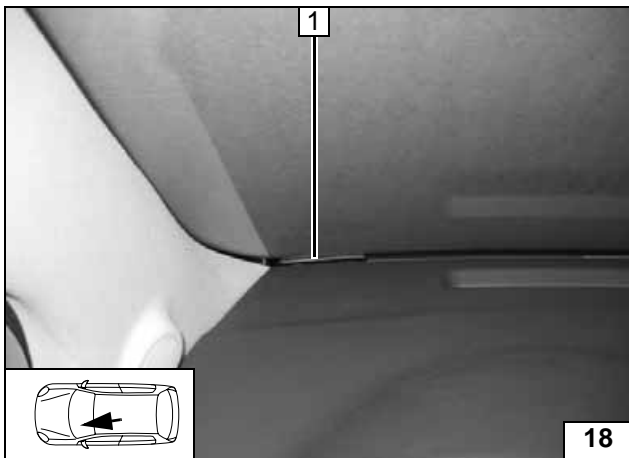

1 Antenna

**Installing antenna**

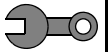

## Final Work

### WARNING!

Reassemble the disassembled components in reverse order.

Check all hoses, clamps and all electrical connections for firm seating.

Secure all loose cables using cable ties.

Only use manufacturer-approved coolant.

Spray the heater unit components with anti-corrosion wax (Tectyl 100K, Order No. 111329).

- Connect the battery
- Fill and bleed the coolant circuit according to the vehicle manufacturer's specifications.
- Set the digital timer.
- Set the manual air conditioning or automatic air conditioning according to the "operating instructions for the end customer".
- Check the proper operation of the additional heater, see the operating instructions/installation instructions.
- Attach the "Switch off additional heater before refueling" sticker to the left-hand B-pillar.



# Webasto

*Feel the drive*

Webasto AG  
Postfach 80 - 82132 Stockdorf, Germany - Hotline +49-  
(0)1805-932278  
Hotfax +49-(0)395-5592-353 - <http://www.webasto.de>

## Operating Instructions for End Customer

Please remove page and add to the vehicle operating instructions.



**Rule of thumb for operating additional heater: driving time = heating time!**

Before parking the vehicle, make the following settings:

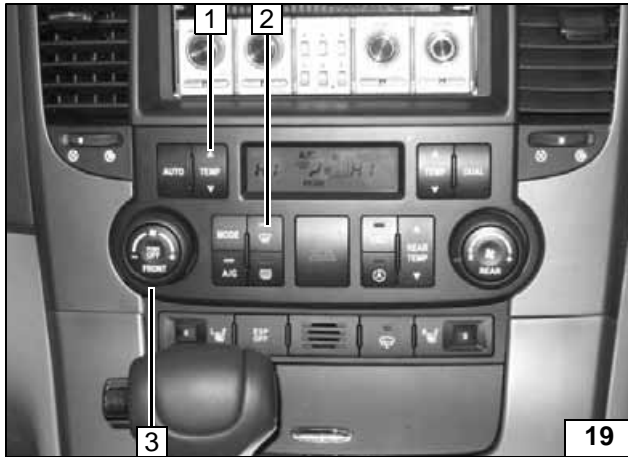

- 1 Set temperature to "max."
- 2 Air outlet to windshield
- 3 Set fan to level "2", or possibly "3"

**For vehicles with automatic air conditioning**